

list 11.2.

PLANIRANO STANJE SAOBRAĆAJ-POPREČNI PROFILI

R 1:100

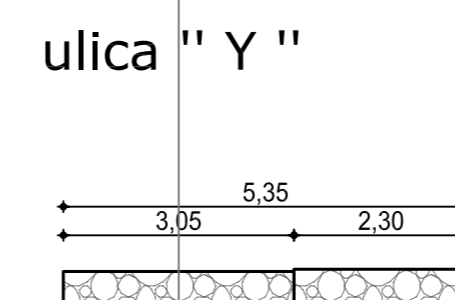
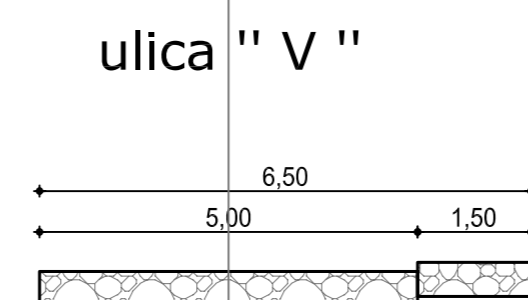
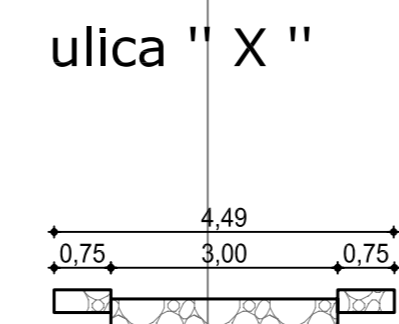
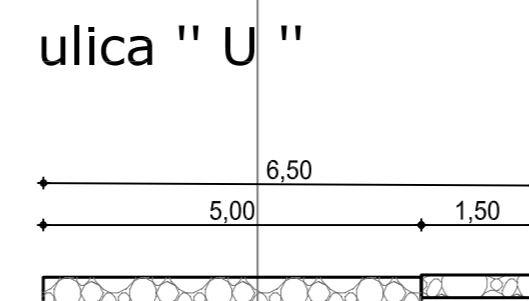
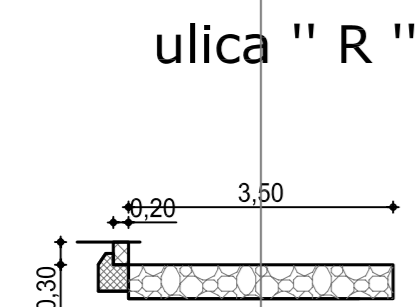
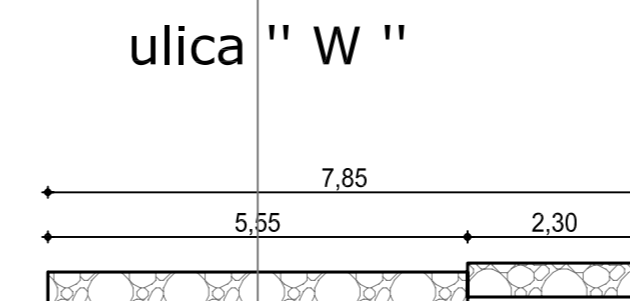
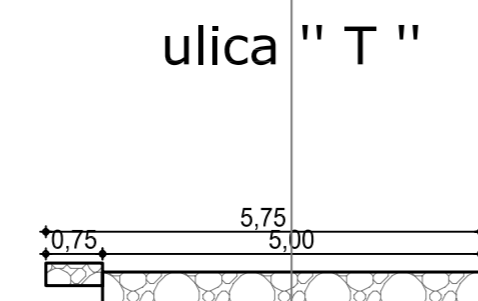
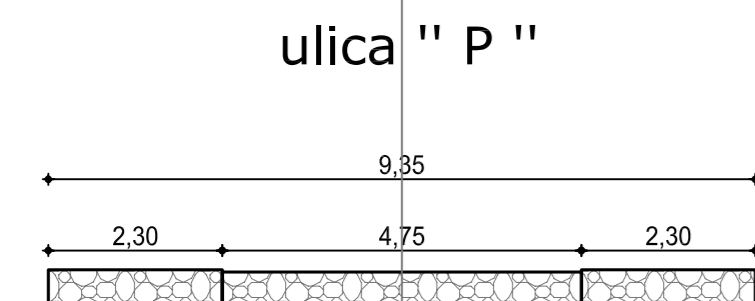
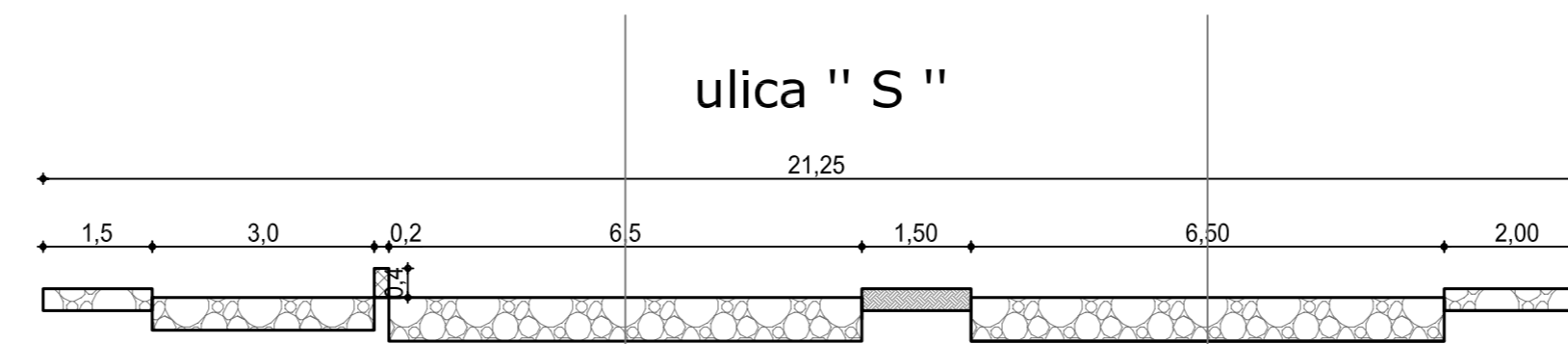
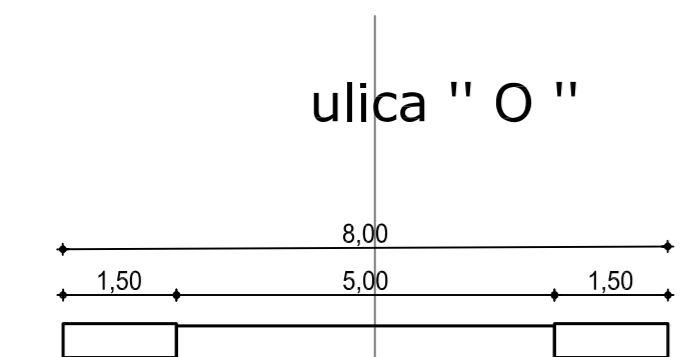

Rozino 2

DETALJNI URBANISTIČKI PLAN

NARUČILAC
OPŠTINA BUDVA
Agencija za planiranje prostora

OBRADIVAČ
ZAVOD ZA IZGRADNJU "BUDVA" AD